

Produktenwicklung



~~Automatisierung~~ als Zukunftschance  
für KMU

## ECKDATEN

- Gründung 1998
- 60+ Mitarbeiter
- Umsatz 12 Mio.
- 2 Standorte
  - Headquarter Oberlienz
  - Niederlassung Nassereith

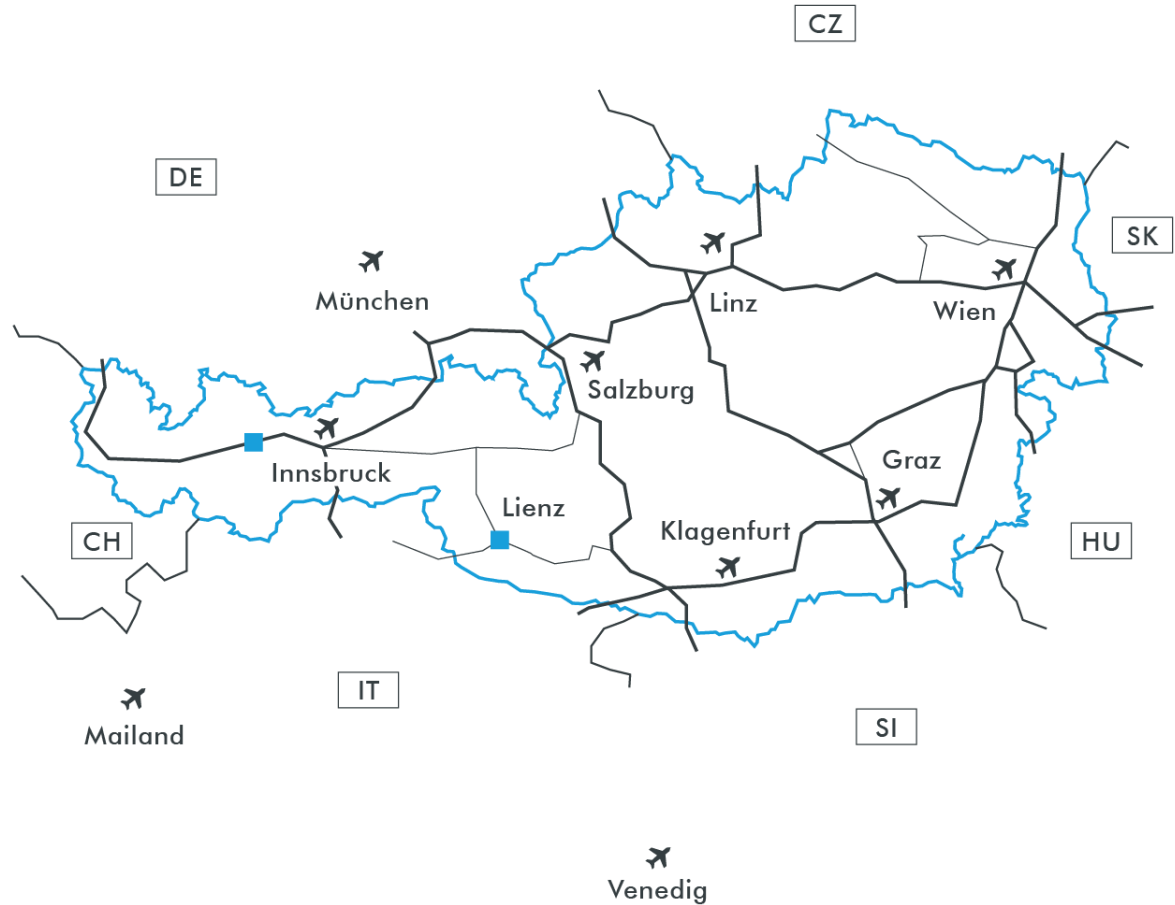



MICADO

Rebanking  
Engineering



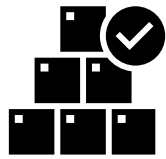

Stückzahlen

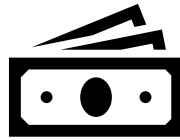

Kosten



Qualität

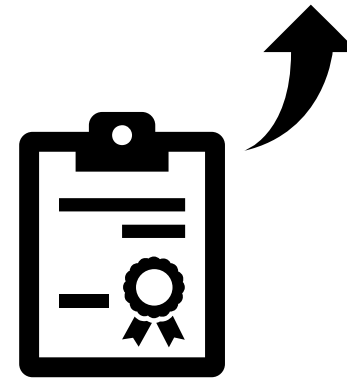
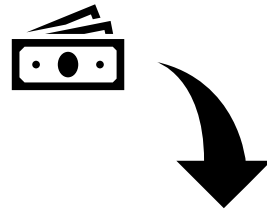
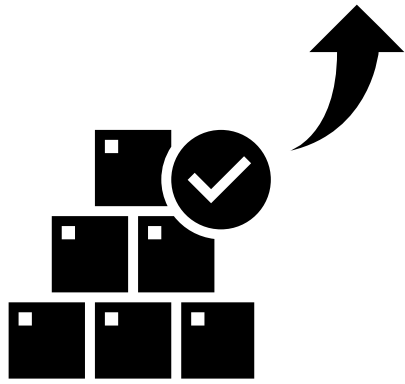

 **MICADO**



**MICADO**

AUSGANGSBASIS IN DER INDUSTRIE

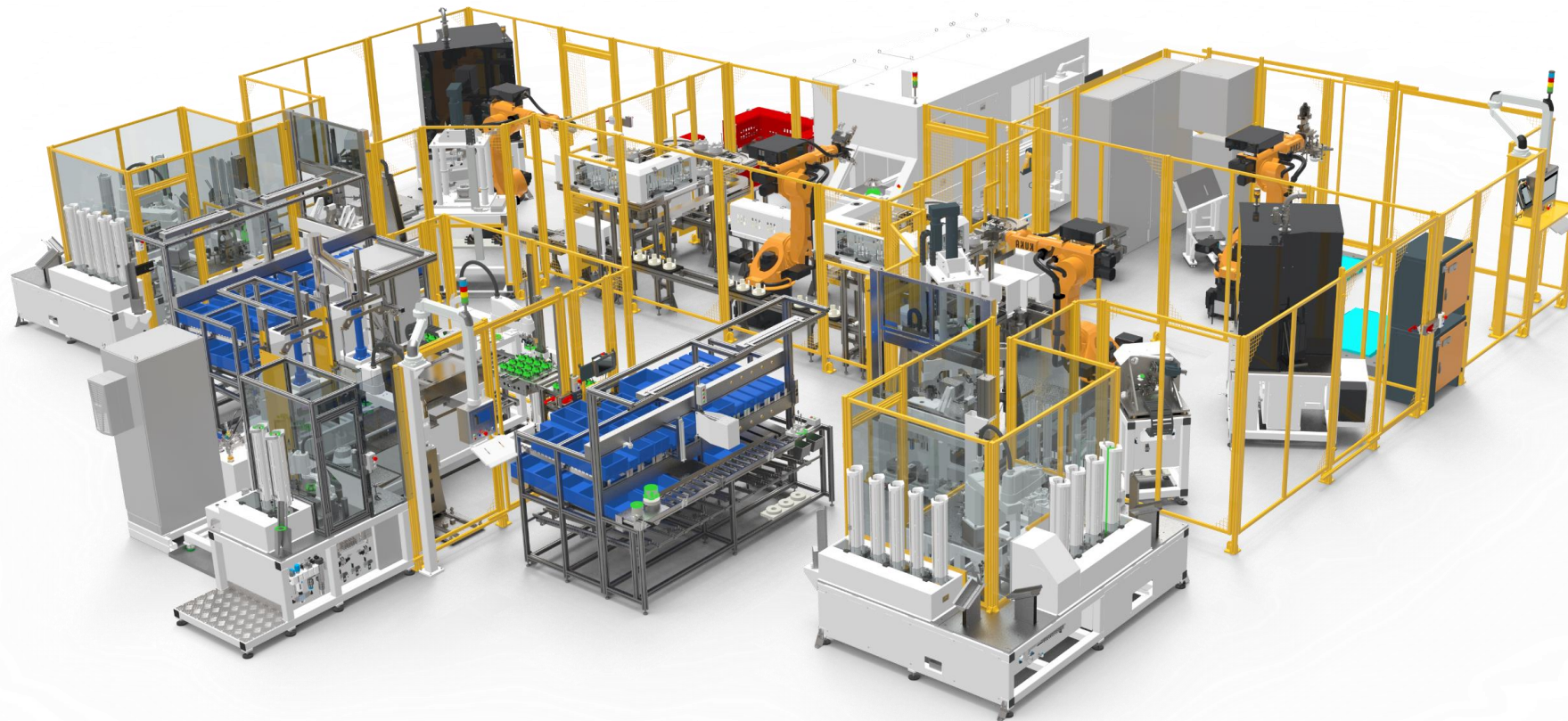



**MICADO**

AUSGANGSBASIS IN DER INDUSTRIE

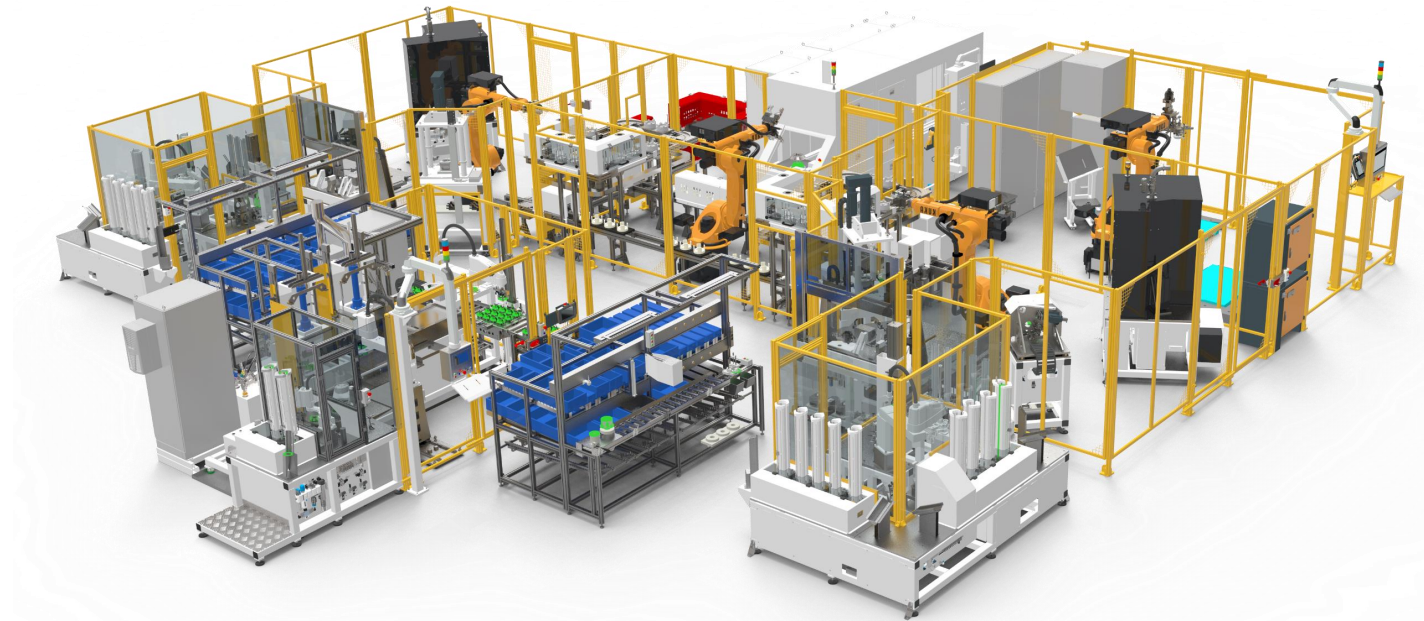
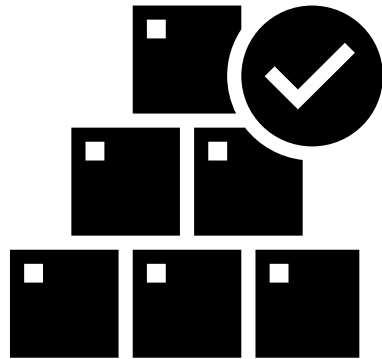

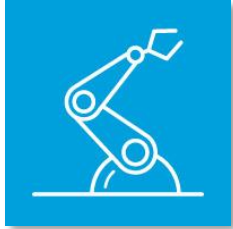

**MICADO**

# Automatisierung als Zukunftschance für KMU





**MICADO**

# Robotik als Zukunftschance für KMU

KOMPLEXITÄT

KOSTEN



KOMPLEXITÄT

KOSTEN

“Einfache” Automatisierung

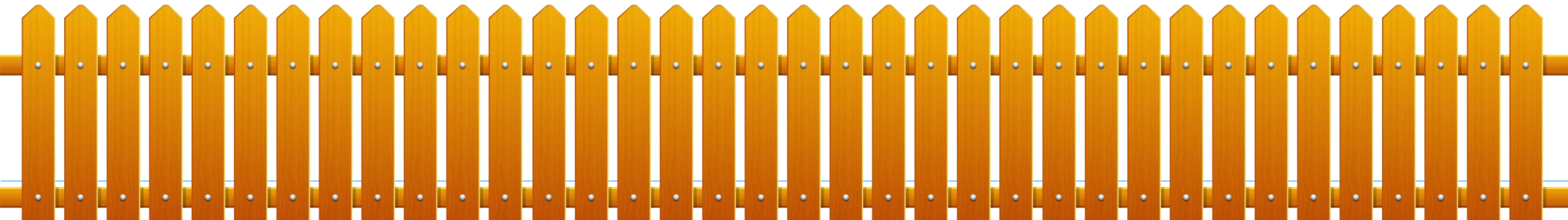

# HUSSL







# KOMPLEXITÄT

# KOSTEN

“Einfache” Automatisierung

Prozess- und Produkt-Adaption

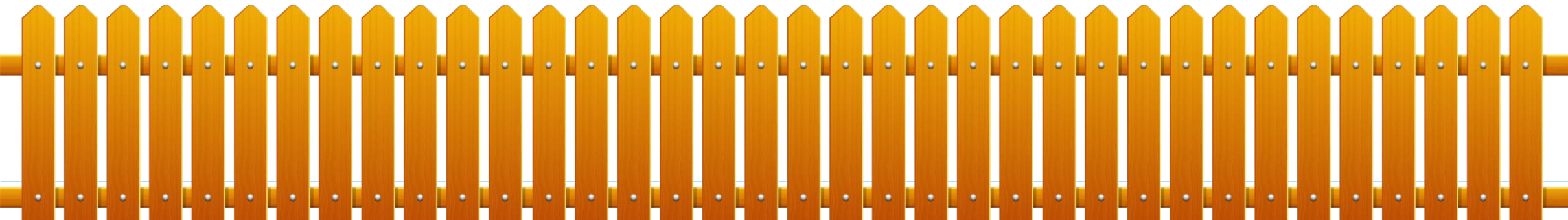



KOMPLEXITÄT

KOSTEN

“Einfache” Automatisierung

Prozess- und Produkt-Adaption





SPORTARTIKEL

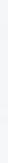

HAUSGERÄTE



ALLGEMEINE INDUSTRIE

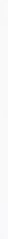

#PRODUCT  
DEVELOP-  
MENT





MICADO



**T** Teufelberger

**MICADO**



**T** Teufelberger

**MICADO**

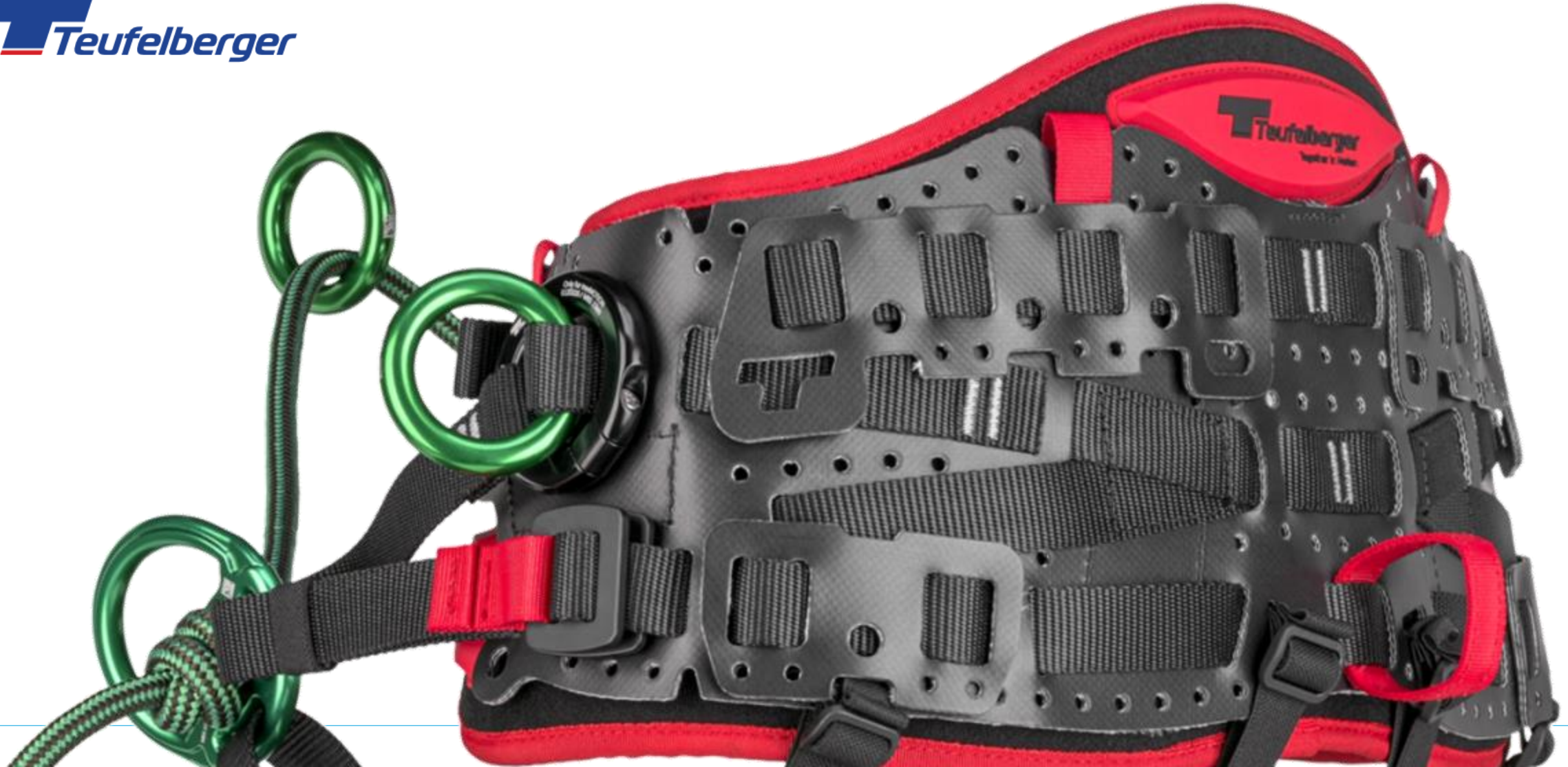

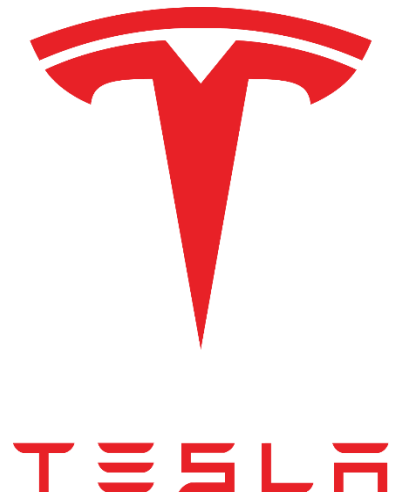

TESLA

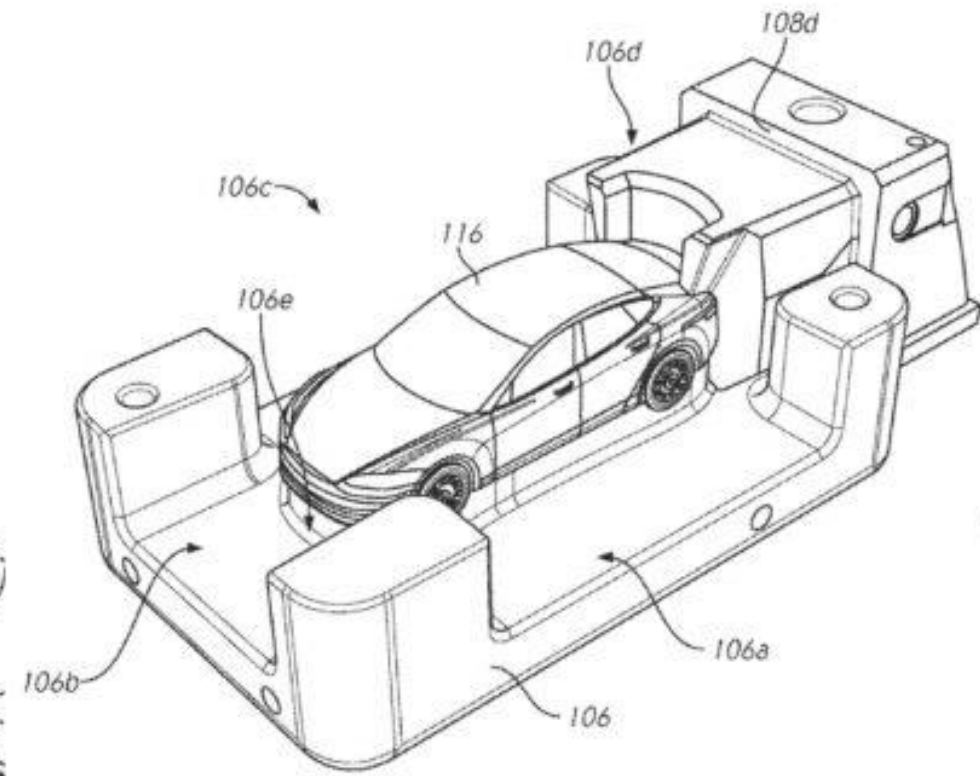
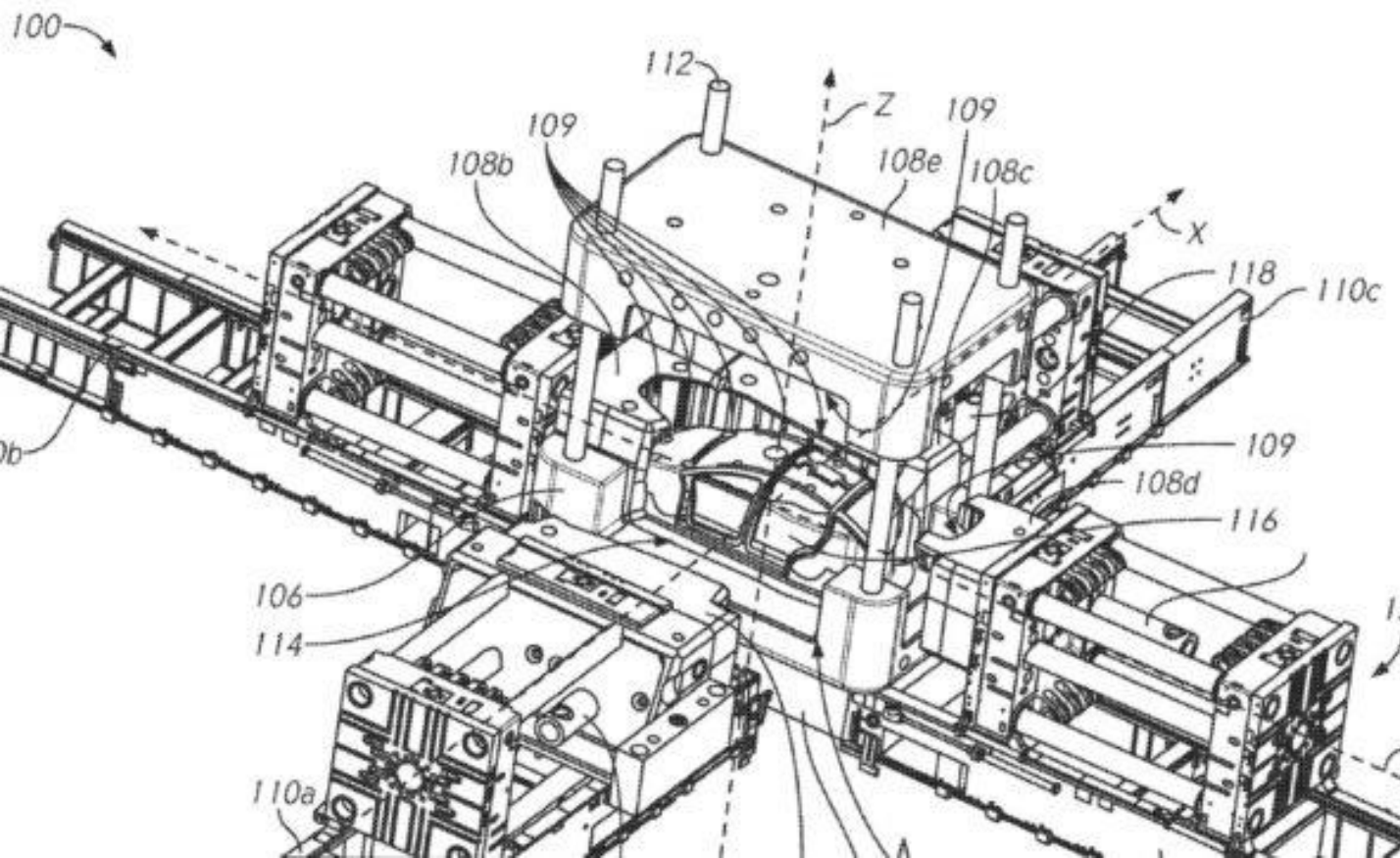

TESLA



Model 3 body structure

171 pieces of metal highlighted

TESLA



Model 3 body structure

171 pieces of metal highlighted



Austin-made Model Y body structure

2 pieces of metal highlighted

>1,600 fewer welds

**GIGAPRESS** going from 5500 to 9000 tons and counting opens a new era in die-casting 'giga' solutions.



TESLA



Model 3 body structure

171 pieces of metal highlighted



Austin-made Model Y body structure

2 pieces of metal highlighted

>1,600 fewer welds

Lasst uns Produkte  
**neu Denken**  
und Barrieren abbauen

